

Made in India

Warning :

- Be sure to check all packing material carefully for small parts, which may have come loose inside the carton during shipment.
- To prevent possible scratches and damage, this furniture **MUST BE ASSEMBLED BY TWO PEOPLE** on a soft surface such as a blanket or carpet.

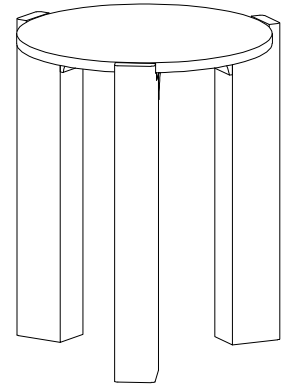

65308
Round End Table Top
65309
Round End Table Base

Components packed with the # 65308 Top

Top



(A) 1 pc.

Components & Hardware packed with the # 65309 Base

Top Mounting Plate

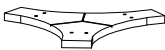

(B) 1 pc.

Leg

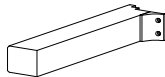

(C) 3 pcs.

5/16-18 x 1-1/2"
Allen Bolt



(D) 6 pcs.

6mm Allen Key

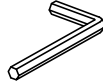

(E) 1 pc.

5/16" Lock Washer



(F) 6 pcs.

5/16" Flat Washer

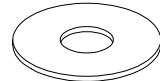

(G) 6 pcs.

Step 1: Using the Allen key to tighten all bolts.

Step 2: Use smooth side of glass on top

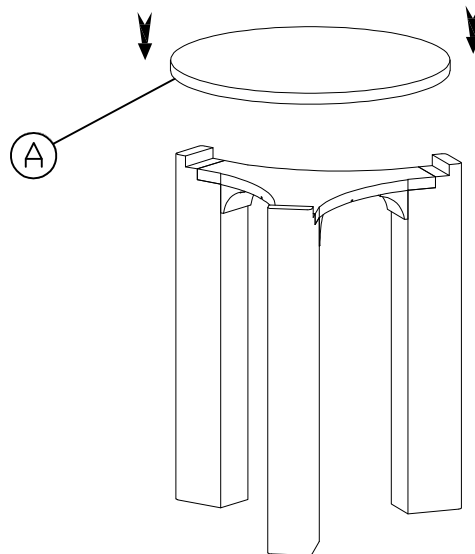
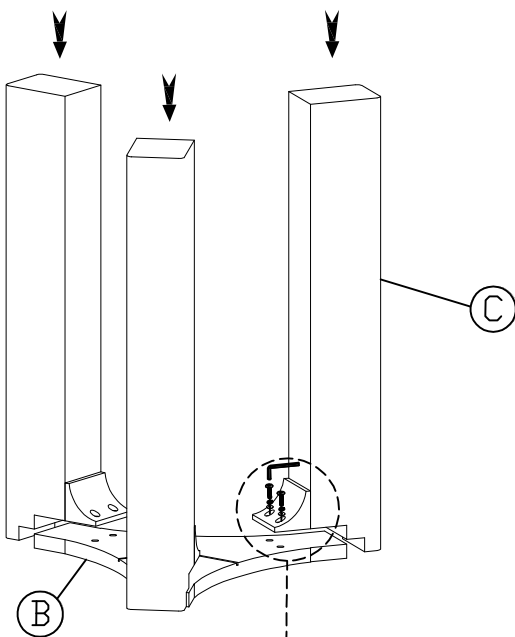

Complete

